

RoHS
COMPLIANT

SPECIFICATIONS



1. Current rating: 3A AC, DC
2. Voltage rating: 125V AC,DC
3. Temperature range: -40°C ~ +125°C
4. Insulation resistance:1000 MΩ Min.
5. Withstanding voltage: 500V AC/ minute.
6. Contact resistance: 10m Ω Max.

Material:

Insulator: PA9T UL 94V-0
 Contact: Phosphor bronze
 Solder tabs: Brass
 Plating: Matte-tin plated over nickel
 Mate with KR2017 series housing



Ordering Code:



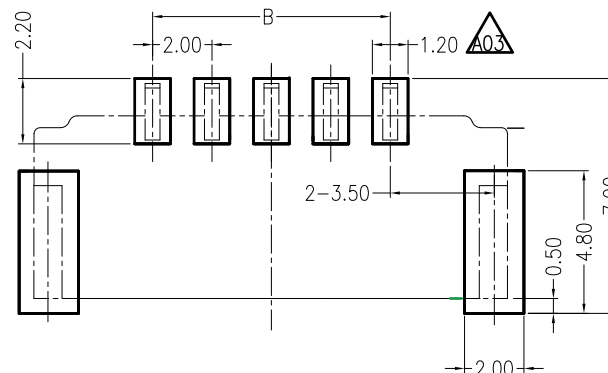
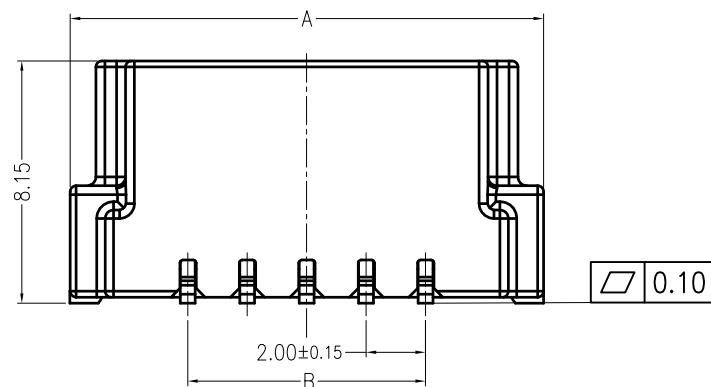
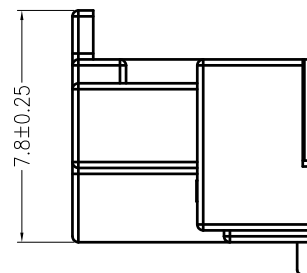
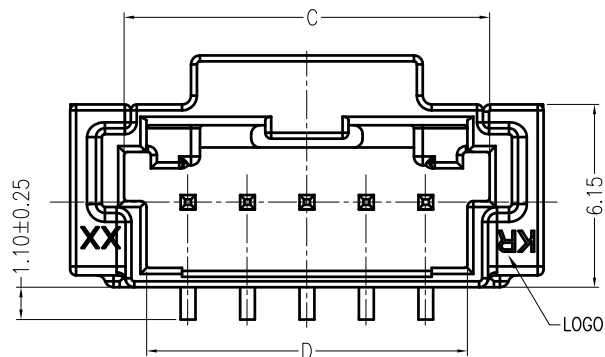

C2017VS *** ** M0101RA

└─ 11:PA9T Natural 
 └─ 12:PA9T Black 
 No.of Circuits
 102 : 2 ... 116,16



Recommended P.C.B. Layout
 General tolerance:±0.05mm

	16	37.90	30.00	34.30	32.80
	15	35.90	28.00	32.30	30.80
	14	33.90	26.00	30.30	28.80
	13	31.90	24.00	28.30	26.80
	12	29.90	22.00	26.30	24.80
	11	27.90	20.00	24.30	22.80
	10	25.90	18.00	22.30	20.80
	9	23.90	16.00	20.30	18.80
	8	21.90	14.00	18.30	16.80
	7	19.90	12.00	16.30	14.80
	6	17.90	10.00	14.30	12.80
	5	15.90	8.00	12.30	10.80
	4	13.90	6.00	10.30	8.80
	3	11.90	4.00	8.30	6.80
	2	9.90	2.00	6.30	4.80
	Circuits	A	B	C	D

	Add specification	ZSZ	2023.6.5	TOLERANCE X.X ±0.30 X.XX ±0.20 X.XXX ±0.10 Angle ±2°	TITLE: MX2.0 Inner buckle SMT 180° Wafer	DRAWN: <i>ZZN</i> 2023.4.19		KONNRA 东莞市康瑞电子有限公司 DongGuan Konnra Electronics Co.,Ltd.		
	Add 13P 15P 16P	ZZN	2023.4.19			CHECKED: <i>ZZN</i> 2023.4.19				
	Uniformly arrange the drawings	ZSZ	2021.09.17			APPROVED:		PART NO.:C2017VS*****M0101RA		
MARK	REVISION DESCRIPTION	SIGNATURE	DATE			UNIT:mm	SCALE:N/A	SHEET:1/1	PROJECTION 	REV.:A05