

RoHS
COMPLIANT

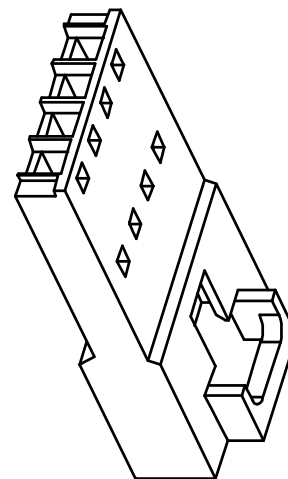

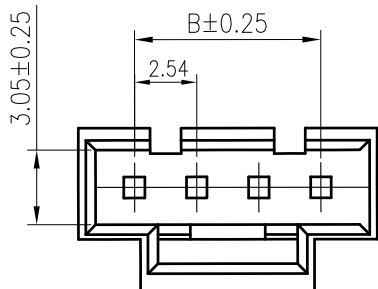
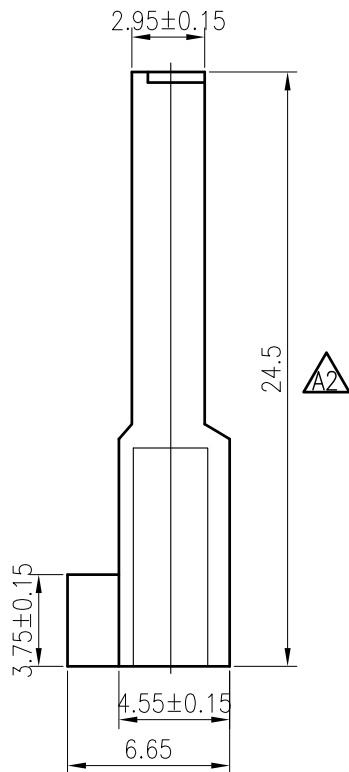
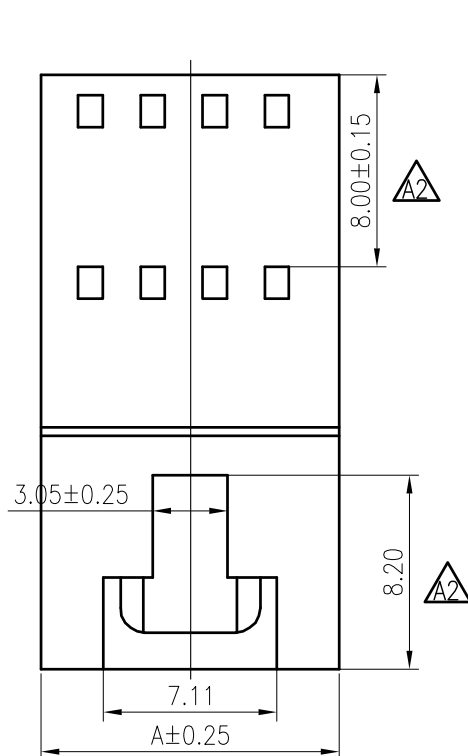

SPECIFICATIONS

1. Current rating: 3A AC, DC
2. Voltage rating: 250V AC,DC
3. Temperature range: -40°C ~ +105°C
4. Insulation resistance: 1000MΩ Min.
5. Withstanding voltage: 1500V AC/ minute.
6. Contact resistance: 20mΩ Max.



Material: PA66 UL 94V-0
Suitable KR2541 series terminal
Mate with KR2541 series wafer

Ordering Code:

H2541F *** ** 01C

No.of Circuits 
102:2,125:25
Insulator Material 
Insulator Material
02:PA66 Black V0

Circuits	Dimensions		Circuits	Dimensions	
	A	B		A	B
2	7.11	2.54	14	37.59	33.02
3	9.65	5.08	15	40.13	35.56
4	12.19	7.62	16	42.67	38.10
5	14.73	10.16	17	45.21	40.64
6	17.27	12.70	18	47.75	43.18
7	19.81	15.24	19	50.29	45.72
8	22.35	17.78	20	52.83	48.26
9	24.89	20.32	21	55.37	50.80
10	27.43	22.86	22	57.91	53.34
11	29.97	25.40	23	60.45	55.88
12	32.51	27.94	24	62.99	58.42
13	35.05	30.48	25	65.53	60.96

				TOLERANCE	TITLE:	DRAWN: <i>Arvin 2020.11.03</i>	KONNRA 东莞市康瑞电子有限公司 DongGuan Konnra Electronics Co.,Ltd.
				X.X ±0.30	MX2.54 Ultra-thin	CHECKED:	
	Modify size	ZSZ	2022.01.12	X.XX ±0.20	Have Buckle Male	APPROVED:	
MARK	REVISION DESCRIPTION	SIGNATURE	DATE	X.XXX ±0.10	Housing		PART NO.: H2541F***0201C
				Angle ±2°	UNIT:mm	SCALE:N/A	REV.: A2
1	2	3	4	5	6	7	8
							DRAWING NO.: 2541HF101-C-S
							9